



Club Car DS Heatsink Assembly with Diodes Installation Instruction

We are striving to build an reliable brand of golf carts parts and accessories.

Hope this manual can assist you to easier install.

For more technical support, please reach us via

Website : www.10LOL.com

Email : sale_service@10LOL.com

Facebook : zhong zaiyang

Youtube : 10LOL



Scan To Get Installation Video

Contents	Qty	Installation Tools	Qty
Heatsink Assembly with Diodes.....	1	Cross screwdriver.....	1
Hardware kit		5/16-inch (8mm) spanner.....	2
Hex nut.....	2	3/8-inch (10mm) spanner.....	1
Flat washer.....	2		
Mounting screw.....	2		

(See figure 1)

Assembly Diagram

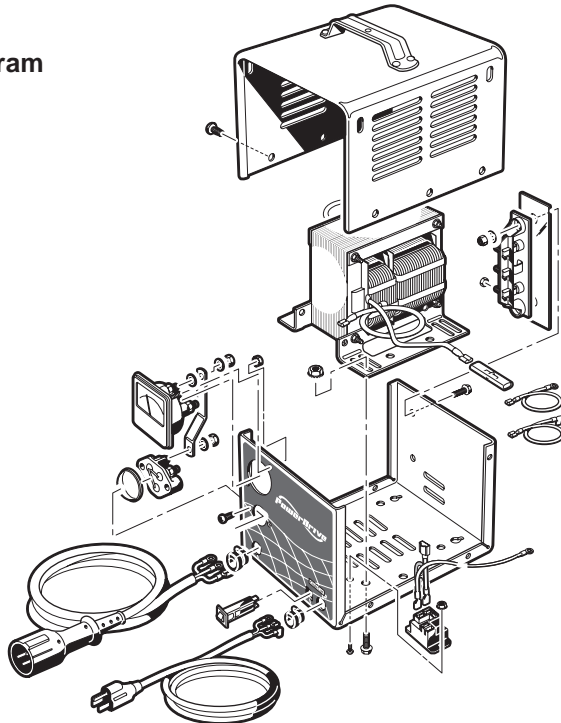

Installation Tools



Installation Steps

1. Park the vehicle on level ground.
2. Turn the key to "OFF" position and remove it from the switch.
3. Make sure the parking brake is set.
4. Disconnect the power and the charger plug.
5. Remove the screws on both sides of the case with the cross screwdriver.

(See figure 2)

6. Remove the case.

(See figure 3)

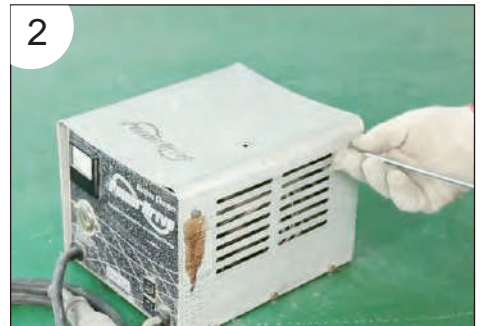

7. Remove 3 screws from the heatsink assembly with diodes with the 3/8-inch (10mm) spanner.

(See figure 4)

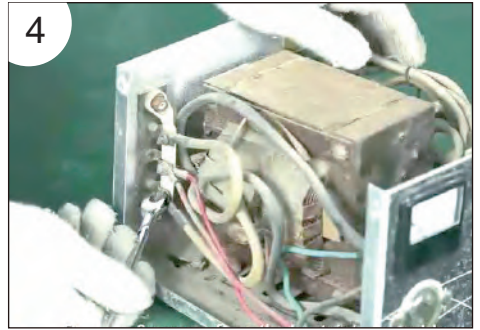

8. Remove 2 screws of the mounting hardware with two 5/16-inch (8mm) spanners.

(See figure 5)

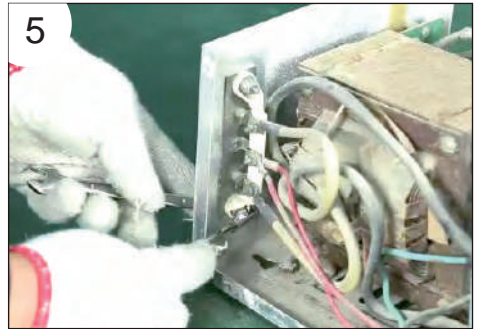

9. Install the new heatsink assembly with diodes.

(See figure 6)

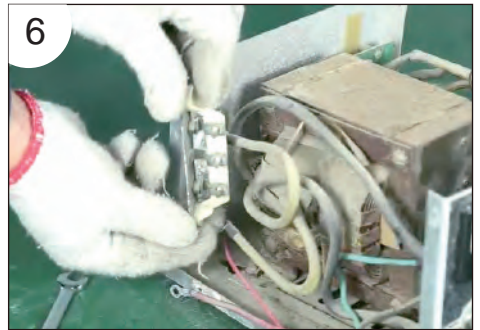

10. Install 2 screws of the mounting hardware with two 5/16-inch (8mm) spanners.

(See figure 7)

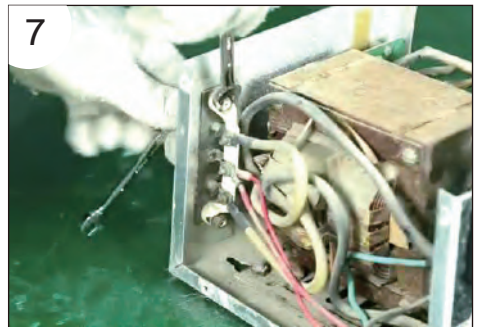

11. Install 3 screws from heatsink assembly with the 3/8-inch (10mm) spanner (The 2 red wires should be fixed in the middle terminal of the heatsink assembly).

(See figure 8)

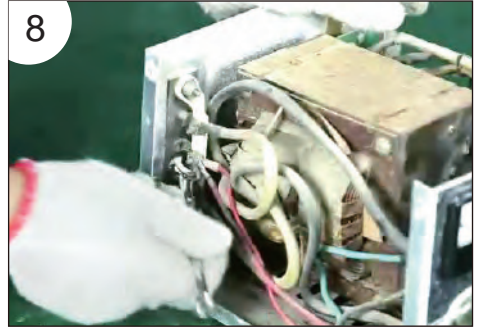

12. Install the case.

(See figure 9)



13. Tighten the screws on both sides of the case with the cross screwdriver.

(See figure 10)

This all completes your installation.

