

FlashFish

E300 Portable Power Station

User Manual

CONTENTS

| | |
|--------------|------|
| English..... | 1-12 |
|--------------|------|

Physical Button Operation Diagram

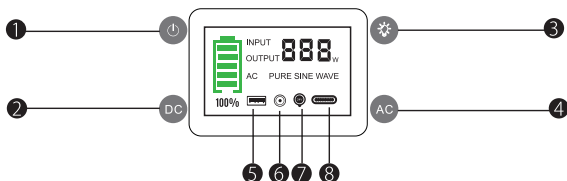

- ① Power Switch Button
- ② DC power Button
- ③ LED light Button
- ④ AC power Button
- ⑤ USB Output Indicator
- ⑥ DC Output Indicator
- ⑦ 24V Cigarette Lighter Output Indicator
- ⑧ PD-Type-c Indicator

1. Long touch the **Power Switch Button** for **5s** to turn on the E300; Long touch the Power Switch Button for **5s** again to turn off. The E300 will turn off automatically if all of outputs are not in used more than **1 minute**.

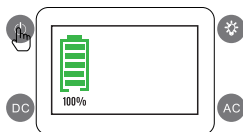

2. After turning on the E300, click the **DC Button** to turn on the DC power, click the DC Physical button again to turn off; DC Output will shut down automatically if it is not in used more that **1 minute**.

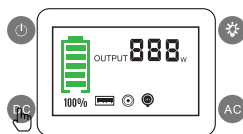

3. After turning on the E300, click the **LED Light Button** the **1st** time to turn on the LED light; Click the button the **2nd** time/the **3rd** time will switch to SOS light mode; Click the LED button the **4th** time to turn off.

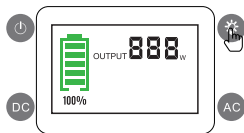

4. After turning on the E300, click the **AC Button** to turn on the AC power, click the button again to turn off.

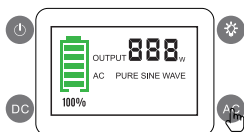

5. The E300 can be used and recharged at the same time, but the LCD screen only shows the charging status.

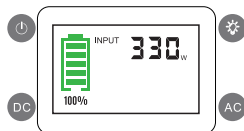

Note: How can I know when the E300 will shut down automatically?

| | | |
|----------------------------|-------------------------------------|------------------------------------------------------------------------------------------------------------------------------------------------|
| When the E300 is turned on | ① Only DC power is turned on. | The E300 will shut down automatically if the dc outputs are not in used more than 1 minute . |
| | ② Only AC power is turned on. | The AC power won't shut down automatically. |
| | ③ Only LED light is turned on | The LED light won't shut down automatically. |
| | ④ DC & AC are turned on | The DC Power will shut down automatically if the dc outputs are not in used more than 1 minute . But AC power won't shut down. |
| | ⑤ DC & LED light are turned on | The DC Power will shut down automatically if the dc outputs are not in used more than 1 minute . But LED light won't shut down. |
| | ⑥ AC & LED light are turned on | Both AC & LED light won't shut down automatically. |
| | ⑦ AC & DC & LED light are turned on | The DC Power will shut down automatically if the dc outputs are not in used more than 1 minute . But AC & LED light won't shut down. |

ATTENTION

The specifications and the pictures in this manual are for reference only. The product is only used for emergency situations, it cannot replace the standard AC power for household appliances or digital products. Actual AC outlet and AC adapter would be different depending on the locations of customer.

Thank you for choosing E300 Portable Power Station. The purpose of this manual is to help you use the product correctly. Please read the manual carefully and follow the guidance.

Product Overview

Front overview

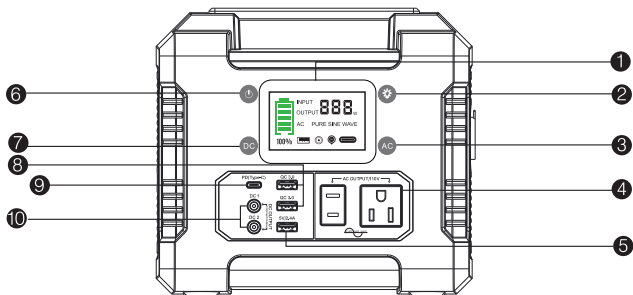

- | | |
|-----------------------------|---------------------------------|
| ① LCD Display | ⑥ Power Switch Button |
| ② LED light Button | ⑦ DC Power Button |
| ③ AC Power Button | ⑧ USB Output Port (QC3.0) |
| ④ AC Socket | ⑨ PD Type-c In/Output Port |
| ⑤ USB Output Port (5V/2.4A) | ⑩ 5.5*2.1mm DC Output (12V/10A) |

Lateral overview

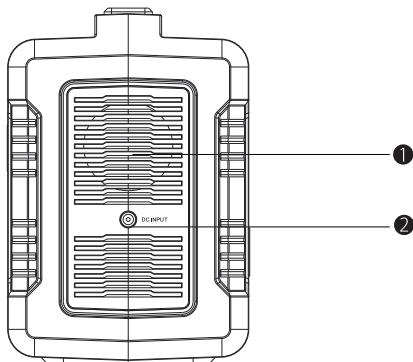

- ❶ Cooling Fan
- ❷ 5.5*2.1mm DC Input Port & Solar Input Port

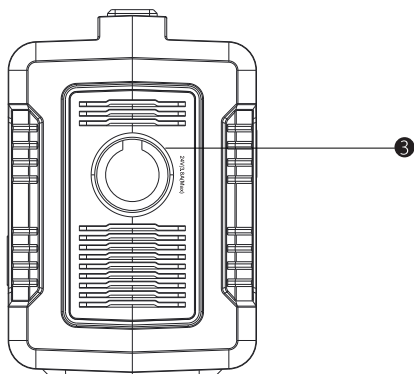

- ❸ 21.5mm DC Output (24V/3.8A(Max))

Rear overview

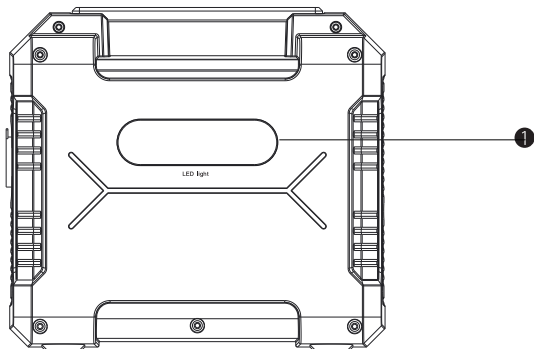

1 LED light

Operation Guidance

1) How to charge with the DC output ports of this product?

Connect your DC 12V/24V appliances with the 12V/24V DC output port. And your appliances would be charged automatically.

※**Note** : Please check to make sure that your 12V DC appliance supports charging with the DC port of this product , which is 5.5*2.1 mm in diameter. You could confirm it with the manufacturer or seller of your 12V/24V DC appliances.

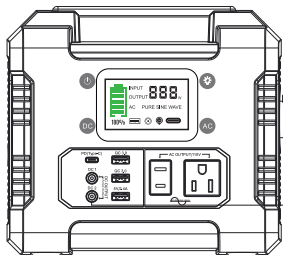

Charge 12V DC appliances (Power < 168W) by plugging into the connector (5.5*2.1 mm in diameter) into the DC output port directly.

※ **Note:** The DC output range of this power station is 12V~16.8V. The maximum output current is 10A. The DC voltage would drop as battery capacity decreases over time. If your appliance does not have built-in input voltage stabilizing function, it may power off due to low voltage. Please remove your appliance and charge the product in time.

Protection Mode (DC Output):

Short-circuit/Over power Protection: If the DC output is short-circuited or overpowered (Load(s) power > 168W), the product will shutdown to protect itself. Please disconnect the 12V appliances from the product and recharge the product. This could help restore the product.

2) How to charge with the AC outlet of this product?

Connect the power cable plug of the AC electrical appliance to the AC outlet of the product. Press the AC power switch and the product will start providing power to your appliances. Please make sure that the power of the AC appliance is less than 330W.

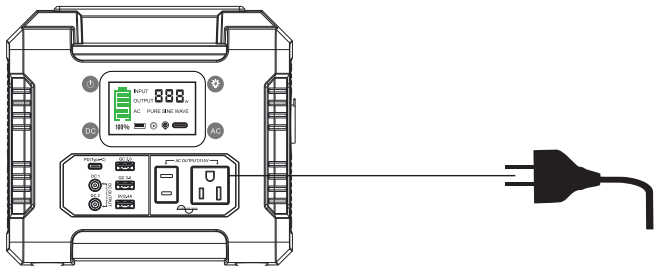

※ **Note:** When the AC port is not in use, turn off the AC power button to conserve power.

Protection Mode (AC Output):

Short-circuit/Overpower Protection: If the AC output is short-circuited or overpowered (load(s) power > 380W), the product will shutdown AC output to protect itself. Please charge this product and re-press the AC button for AC output.

Some electronic devices, such as refrigerator, ice maker or a laser printer may require a surge power to start or work. The surge power could exceed 380W, which could cause overpower protection. Please disconnect the devices and consult with the device manufacturers for more information.

3) How to charge with the USB ports of this product?

Connect the standard USB cable of your digital devices to the USB output ports of the product. Press the DC power button the product will start providing power. If the USB port fail to supply power to the digital device, press the AC power output button to trigger USB power output.

Please switch off the AC power output to save power when your digital devices are fully charged.

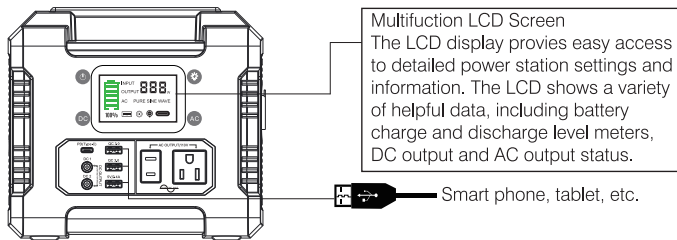

4) How to charge the product?

A. Charge through AC wall charger

Connect the power adapter which comes with the product to any wall outlet. When the battery icon on the LCD screen flashes, it indicates that the product is being charged.

| No. of Indicator light | 1 indicator light blinks | 2 indicator light blinks | 3 indicator light blinks | 4 indicator light blinks | 5 indicator light blinks |
|------------------------|--------------------------|--------------------------|--------------------------|--------------------------|--------------------------|
| Battery status | 0%-20% charged | 20%-40% charged | 40%-60% charged | 60%-80% charged | 80%-100% charged |

The product is fully charged when the battery icon on the LCD screen stops flashing, indicating that the product is fully charged. After the product is fully charged, please unplug the AC wall charger in time.

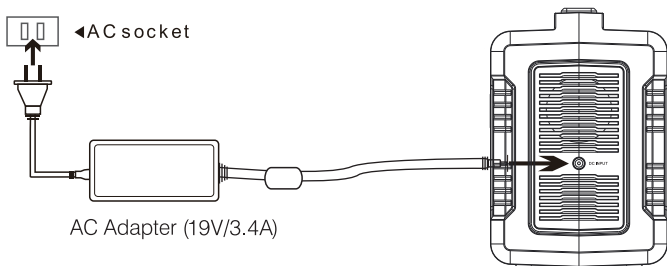

B. Charge through solar panel

1. Place your solar panel where it will get as much strong direct sunlight as possible.
2. Connect the output port of the solar panel with the input port of the product to start charging. When the battery icon on the LCD screen is flashing ,the product is being charged normally. When the battery icon on the LCD screen is stop flashing, the product is fully charged.

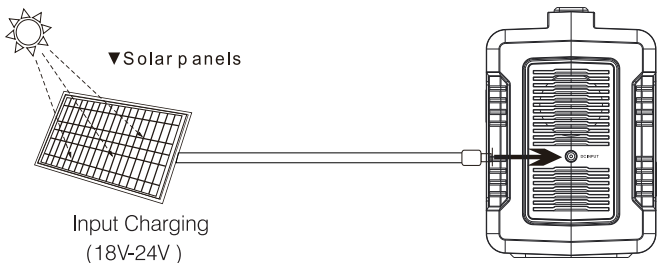

※ **Note:** Actual charging efficiency can vary widely depending on weather, temperature, battery state of charge, and other factors.

C. Charge through the cigarette lighter receptacle of your 19V-24V car

Using the car charger , plug product into the 19V-24V cigarette lighter receptacle of your car . when the battery icon on the LCD screen is flashing , You will know the product is charging. When the battery icon on the LCD screen is stop flashing, the product is fully charged.

Attention: To avoid car battery power loss, you should charge this product through your car cigarette lighter only when your car engine is started. This function is for 19V-24V car .

Cautions

1. Do not short-circuit the product. To avoid short-circuiting, keep the product away from all metal objects (e.g. coins, hair-pins, keys, etc.).
2. Do not heat the product, or dispose it in fire, water or other liquids. Keep it away from high ambient temperature. Do not expose the product to direct sunlight.
3. Keep the product away from humid, dusty places.
4. Do not disassemble or reassemble this product.
5. Do not drop, place heavy objects on, or allow strong impact to this product.
6. This product is not intended to be used by persons with reduced physical, sensory or mental capabilities.
7. Please keep this product away from children.
8. Do not cover the product with towels, clothing and other item.
9. Do not over-charge this product.
10. When fully charged, disconnect the product from the power source immediately.
11. Please double check the total power of your await for charging devices before use this product. Make sure not exceed the rated power of this power station.

Product Application Tips

1. It is recommended to use this product when the ambient temperature falls within $-10^{\circ}\text{C} \sim 40^{\circ}\text{C}$, so as to obtain the optimal charging capacity.
2. When charging this product, please keep it away from TV, radio and other equipment to avoid radio wave interference.
3. If you are not going to use this product for a long time, please disconnect the cable before storing it away.
4. To charge some portable electronic devices, you may need to set those devices in charge mode first. Refer the corresponding user manual of those devices for confirmation.
5. In order to extend the life of product (lithium battery), it is best to charge it once every 3 months, or at least charge it once every 6 months.

Cold Weather Usage

Cold temperatures (below freezing) can affect the product's battery capacity due to chemical characteristics of the battery. If you'll be living off grid in sub-zero conditions, it is recommended to keep your product in an insulated cooler, and connected to a power source (solar panels). The natural heat generated by the product contained in an insulated cooler will keep battery capacity at its highest.

Disposal and Recycle

This product should not be disposed along with household waste. Please dispose or recycle this product and the battery inside according to the local rules and regulations.

Battery Information

This product has an internal, non-removable, rechargeable battery. Do not attempt to remove the battery, as this may cause serious injury to you or damage to the device.

Pure Sine Wave Output

This product generates pure sine wave, which is compatible with AC electric appliance that works with Sinusoidal waveform (power <330W). However, the product is only used for emergency situations. It cannot replace the standard DC or AC power supply for household appliances or digital products. Electronic appliances that use an AC motor isn't going to work to its full capacity on a pure sine wave and noises may sound as a result. For long-term use, appliances like refrigerators, microwaves, and compressors that use AC motors and some delicate medical equipment will be better off with the standard DC or AC power supply.

Product Specifications

| | |
|----------------------------|-------------------------------------------------|
| Model | E300 |
| Battery | Lithium-ion Battery, 18650, 300Wh |
| AC Output | AC Pure Sine Wave Output |
| AC Continuous Power Output | 330W |
| AC Peak Power Output | 380W |
| Standard Out Voltage | 110V |
| Input (Adapter) | DC 19V/3.4A |
| Input (Solar Panel) | 18V-24V |
| USB Output | 2 x USB Output QC 3.0 1 x USB Output 5V/2.4A |
| PD Type-c Output | 45W |
| DC Output | 12-16.8V/10A (Max);24V/3.8A(Max) |
| Solar Charging | Recommend 18-24V 100W solar panel |
| Charging Time | 5-6 hours (with 19V/3.4A adapter) |
| Operation Temperature | -10°C ~ 40°C |
| Life cycle | >800 times |
| Dimensions (LWH) | 209*130*192MM |
| Net Weight | About: 2.9 kg |
| Gross Weight | About: 3.8kg |

Package Contents

- 1 x Portable Solar Generator
- 1 x Power Adapter
- 1 x Cigarette Lighter Adapter
- 1 x Car Charger
- 1 x User Manual

Warranty

Our company provides customers with warranty of 12 months from the date of purchase.



Email: info@flashfishtech.com

For more promotions, discount, coupons, activities or technical support, after-sales please feel free to contact us

Flashfish Team:

Website: www.flashfishtech.com (more contact info could be found on our website)



MADE IN CHINA